

SIKU VKMz SERIE



Innovativer, geräuscharmer und zuverlässiger Rohrventilator zur Be- und Entlüftung verschiedener Gebäudearten.

Die VKMz Serie wird für Räume mit hohen akustischen Anforderungen empfohlen.

PRODUKTBESCHREIBUNG

- Kugellagermotor
- eine Außenwandmontage ist möglich
- **das Gehäuse besteht aus verzinktem Stahl**
- einphasiger Außenläufermotor mit Radiallaufrad und rückwärts gekrümmten Schaufeln
- kann in beliebiger Position montiert werden
- maximale Temperatur der geförderten Luft: +55°C
- stufenlose oder stufenweise Regelung über einen Thyristor- oder Trafo-Drehzahlregler
- inklusive Überhitzungsschutz
- Wandbefestigung mit Hilfe von Befestigungswinkeln (im Lieferumfang enthalten)
- der Anschluss ans Stromnetz erfolgt über den externen Klemmkasten



IPX4



TECHNISCHE DATEN

MODELL	SPANNUNG 50/60 HZ	LEISTUNGS- AUFNAHME	STROMAUF- NAHME	DREHZAHL	LUFTFÖRDER- LEISTUNG	SCHALLDRUCK- PEGEL BEI 3 M	GEWICHT	SCHUTZART
SIKU VKMz 100	230V	72W	0,32 A	2820 min ⁻¹	250m ³ /h	46 dBA	3,16 kg	IPX4
SIKU VKMz 125		78W	0,34 A	2820 min ⁻¹	330 ³ /h	46 dBA	3,16 kg	
SIKU VKMz 160		78W	0,34 A	2760 min ⁻¹	455m ³ /h	46 dBA	3,44 kg	
SIKU VKMz 200		157W	0,69 A	2740 min ⁻¹	1000m ³ /h	50 dBA	5,43 kg	
SIKU VKMz 250		152W	0,66 A	2765 min ⁻¹	1070m ³ /h	52 dBA	5,25 kg	
SIKU VKMz 315		185W	0,81 A	2730 min ⁻¹	1540m ³ /h	53 dBA	6,57 kg	

MODELL	D (MM)	D1 (MM)	B (MM)	B1 (MM)	L (MM)	L1 (MM)	L2 (MM)	L3 (MM)
SIKU VKMz 100	99	237	253	293	202	23	22	30
SIKU VKMz 125	123	237	253	293	202	23	22	30
SIKU VKMz 160	158	278	294	334	200	25	23	30
SIKU VKMz 200	198	332	340	380	245	25	29	40
SIKU VKMz 250	249	332	340	380	213	25	29	40
SIKU VKMz 315	313	402	410	450	308	33	55	40

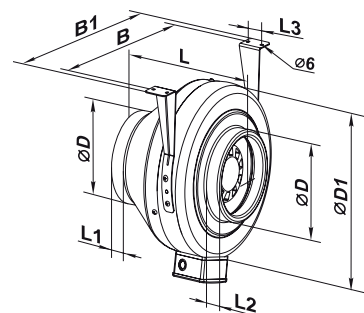

LEISTUNGSDIAGRAMM UND ANWENDUNGSBEISPIEL

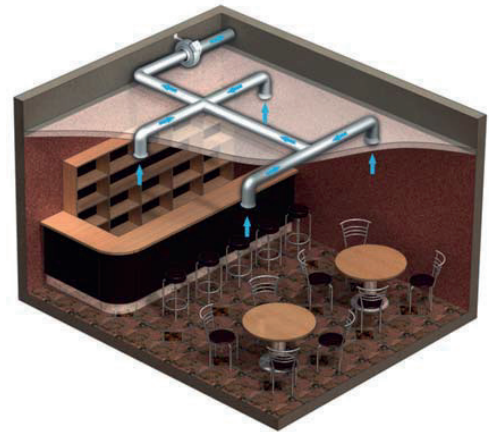
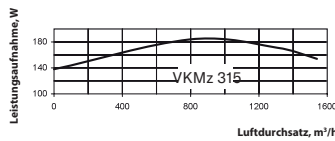
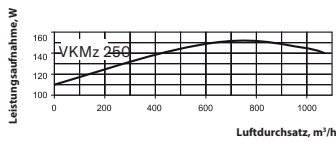
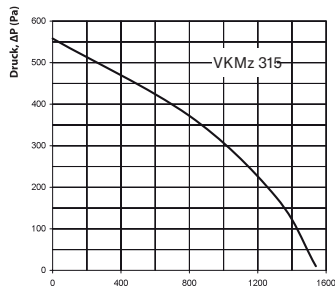
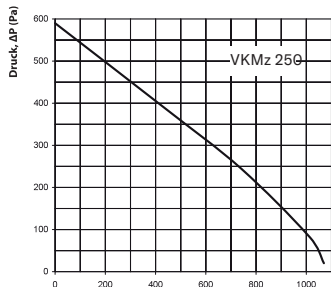
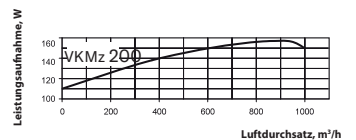
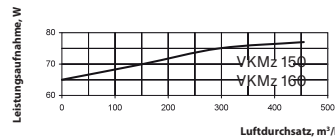
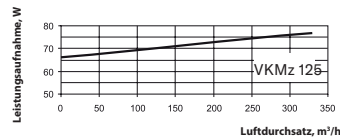
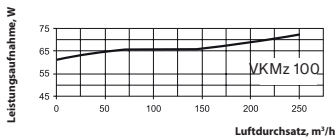
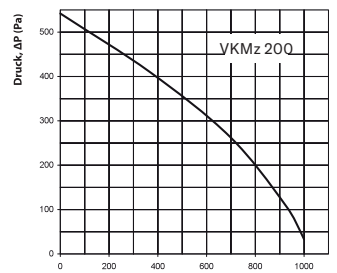
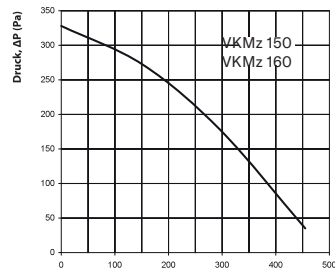
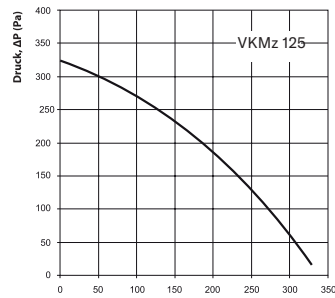
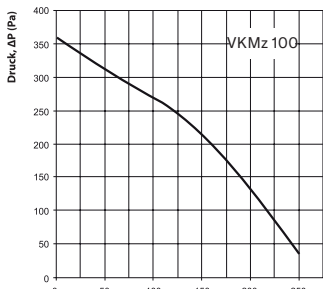

VERFÜGBARE MODELLE KUGELLAGER

ARTIKELNUMMER

VERPACKUNGSEINHEIT

SIKU VKMz 100	(Art. Nr. 50566)	1 Stück
SIKU VKMz 125	(Art. Nr. 50567)	1 Stück
SIKU VKMz 160	(Art. Nr. 50568)	1 Stück
SIKU VKMz 200	(Art. Nr. 50569)	1 Stück
SIKU VKMz 250	(Art. Nr. 50570)	1 Stück
SIKU VKMz 315	(Art. Nr. 50571)	1 Stück

ZUBEHÖR

SCHALLDÄMPFER

LUFTKLAPPEN

DREHZAHLREGLER

